



ACCESSOIRES DE LUBRIFICATION

SYSTÈMES D'ARROSAGE & ACCESSOIRES
LA GAMME LA PLUS COMPLÈTE DU MARCHÉ

SYSTÈMES 1/4" - 3/8" - 1/2" - 3/4"

STOCK IMPORTANT

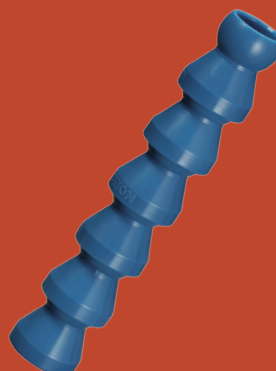

Livraison 24H* avec TNT!

*(Pour toute commande passée avant 15h)

CARACTÉRISTIQUES GÉNÉRALES

Matière & Utilisation

Matière : Acétal (Dupont 100P)
 Point de fusion 165°C
 Température maximum du fluide 65°C



☺ Utilisable pour les fluides suivants : Acétone, Alcools & Ethyles, Détergents commerciaux, Essences, Graisses, Solvants pour vernis, Huiles, Huiles solubles, Hydroxyde de sodium (soude caustique), Insecticide, Liquide de frein

Ø intérieur	pression max	débit max
1/4"	3.4 Bar	15L/min
3/8"	3.0 Bar	25L/min
1/2"	2.0 Bar	29L/min
3/4"	1.4 Bar	32L/min

NPT / BSPT

NPT Conique

Désignation en pouces	1/8	1/4	3/8	1/2	3/4
Nombre filets au pouce	27	18	18	14	14
Pas en mm	0.94	1.41	1.41	1.81	1.81
Ø extérieur mâle (DE)	10.4	13.8	17.3	21.6	26.9
Longueur filetage (L)	9.5	14.3	14.3	19	19
Ø perçage (DP)	8.3	10.7	14.3	17.5	22.6
Ø alésage conique (DC)	8.8	11.4	15.1	18.5	23.6
Longueur perçage (P)	11.7	17	17.3	22.9	23.1



BSPT Gaz Conique

Désignation en pouces	1/8	1/4	3/8	1/2	3/4
Nombre filets au pouce	28	19	19	14	14
Appellation commune	5/10	8/13	12/17	15/21	20/27
Pas en mm	0.90	1.33	1.33	1.81	1.81
Ø extérieur mâle (DE)	10	13.6	17.1	21.6	27.1
Longueur filetage (L)	9	12.5	13	17	18.5
Ø alésage (DA)	8.5	11.4	14.9	18.6	24.1

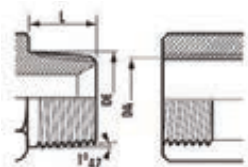

Informations Complémentaires

- Entièrement compatible avec les produits de la marque «référence» sur le marché
- Extrêmement facile d'utilisation : ajustement en longueur et en position
- Insensible aux vibrations
- Non conducteur d'électricité : utilisable sur les machines d'électroérosion
- Ø intérieur constant quelque soit la position d'utilisation

Les références SGD

Code Article	Page	38156D	10	41479D	4	51809D	16	59895D	17
21191D	6	38173D	9	41480D	8	51810D	15	59897D	16
21192D	5	38200D	9	41481D	8	51811D	15	59898D	16
21193D	5	38201D	9	41482D	8	51812D	16	60513D	18
21194D	6	38202D	9	41483D	7	51821D	15	60514D	18
21195D	4	38203D	9	41484D	7	51822D	15	60525D	19
21198D	4	38430D	9	41485D	7	51823D	14	60526D	19
21199D	4	38431D	9	41486D	7	51824D	15	60527D	19
21200D	8	38651D	11	41488D	8	51825D	15	60528D	19
21201D	5	38722D	11	41489D	7	51826D	14	60529D	19
21202D	5	38723D	10	41500D	7	51827D	14	60530D	19
21203D	8	38724D	10	49420D	6	51828D	16	60531D	18
21204D	8	38725D	11	49421D	6	51829D	16	60532D	18
21205D	8	38726D	10	49422D	7	51830D	16	60533D	18
21210D	8	38727D	10	49423D	7	51831D	16	61500D	19
21211D	5	38742D	11	49424D	7	51832D	16	61501D	19
21212D	5	38743D	10	49425D	5	51833D	15	61502D	18
21213D	8	38744D	10	49426D	5	51834D	15	61503D	18
21214D	8	38745D	11	49427D	7	51835D	15	61505D	18
21215D	8	38746D	10	49428D	6	51836D	15	61507D	18
21221D	14	38747D	10	49429D	6	51837D	13	61508D	19
21222D	14	38851D	11	49431D	8	51838D	17	61509D	18
21231D	14	39851D	15	49432D	5	51840D	16	61510D	19
21232D	14	39852D	14	49434D	5	51841D	16	61511D	19
29451D	6	39853D	14	49435D	6	51842D	17	61512D	19
29452D	5	39854D	15	49436D	6	51843D	17	61514D	19
29453D	5	40413D	4	49437D	5	51845D	17	61515D	19
29454D	6	40414D	4	49438D	5	51847D	16	69540D	19
32091D	15	40459D	4	49439D	7	51848D	16	69541D	19
32092D	14	40460D	4	49440D	7	59852D	16	69542D	18
32093D	14	40461D	4	49441D	7	59860D	15	69543D	18
32094D	15	40462D	4	49442D	7	59861D	15	69545D	18
32095D	13	41400D	6	49443D	6	59862D	16	69547D	18
32098D	13	41401D	6	49445D	6	59863D	16	69548D	19
32099D	13	41402D	7	49446D	6	59864D	14	69549D	18
38026D	10	41403D	7	49447D	8	59865D	14	69551D	19
38030D	8	41404D	7	49449D	8	59866D	16	69552D	19
38031D	11	41405D	5	49450D	8	59867D	16	69554D	19
38032D	11	41406D	5	49451D	7	59868D	15	69555D	19
38033D	11	41407D	7	49452D	7	59869D	15	78001D	4
38034D	11	41408D	6	49453D	7	59870D	15	78002D	13
38035D	10	41409D	6	49454D	7	59871D	16	78004D	18
38036D	10	41410D	6	49455D	8	59872D	15		
38037D	11	41411D	8	49456D	7	59873D	14		
38038D	11	41412D	5	49500D	7	59874D	15		
38040D	9	41414D	5	50813D	13	59875D	15		
38041D	11	41415D	6	50814D	13	59876D	14		
38046D	10	41416D	6	50815D	13	59877D	14		
38051D	11	41417D	5	50816D	13	59878D	16		
38052D	11	41418D	5	50817D	13	59879D	16		
38053D	11	41420D	4	50818D	13	59880D	16		
38054D	11	41470D	7	51800D	15	59881D	16		
38055D	10	41471D	7	51801D	15	59883D	15		
38056D	10	41472D	7	51802D	16	59884D	15		
38057D	11	41473D	7	51803D	16	59885D	17		
38058D	11	41474D	7	51804D	14	59889D	15		
38091D	11	41475D	6	51805D	14	59890D	16		
38135D	10	41476D	6	51806D	16	59891D	16		
38136D	10	41477D	6	51807D	16	59892D	17		
38155D	10	41478D	6	51808D	15	59893D	17		

SYSTÈMES ARROSAGE 1/4"

Raccords d'entrée

page 5



Éléments intermédiaires

page 6

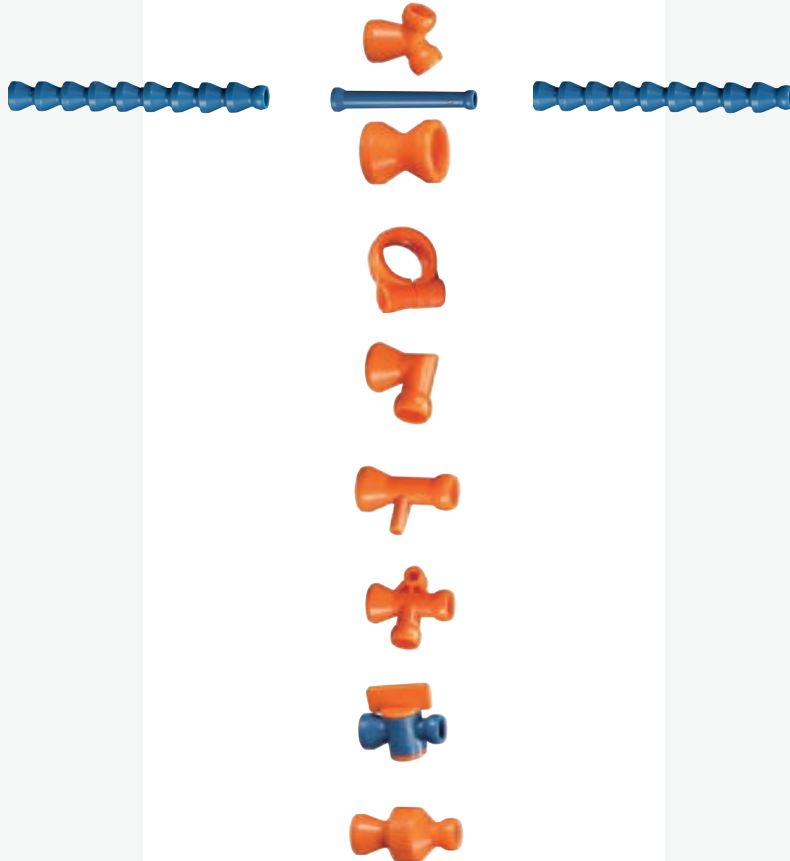

Éléments de sortie

page 7-8



■ Kits & Accessoires 1/4" : Page 4

SGD
SOLUTIONS de DEGRAISSAGE

Arrosage Haute Pression - Filtration

Équipement pour le nettoyage
industriel et l'environnement

Tél. 04 50 96 17 52
info@sgd-france.com
www.sgd-france.com



KITS & ACCESSOIRES 1/4"

Kit NPT

Réf. 40413D

2 segments de 15 cm,
1 buse droite Ø 1.6 mm,
1 buse droite Ø 3.2 mm,
1 buse droite Ø 6.35 mm,
1 raccord entrée mâle fileté
1/8 NPT,
1 raccord entrée mâle fileté
1/4 NPT

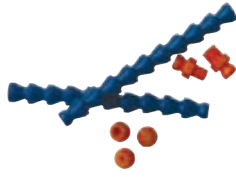

Kit BSPT

Réf. 40414D

2 segments de 15 cm,
1 buse droite Ø 1.6 mm,
1 buse droite Ø 3.2 mm,
1 buse droite Ø 6.35 mm,
1 raccord entrée mâle fileté
1/8 BSPT,
1 raccord entrée mâle fileté
1/4 BSPT

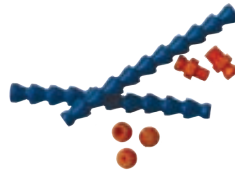

Raccord complet avec robinet mâle 1/4 NPT

Réf. 40460D

2 segments de 15 cm,
1 buse droite Ø 1.6 mm,
1 buse droite Ø 3.2 mm,
1 buse droite Ø 6.35 mm,
1 robinet mâle 1/4 NPT

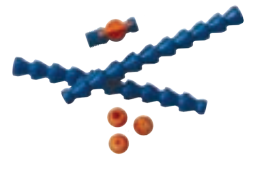

Raccord complet avec robinet mâle 1/4 BSPT

Réf. 40459D

2 segments de 15 cm,
1 buse droite Ø 1.6 mm,
1 buse droite Ø 3.2 mm,
1 buse droite Ø 6.35 mm,
1 robinet mâle 1/4 BSPT

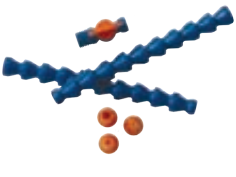

Raccord complet avec robinet femelle 1/4 NPT

Réf. 40462D

2 segments de 15 cm,
1 buse droite Ø 1.6 mm,
1 buse droite Ø 3.2 mm,
1 buse droite Ø 6.35 mm,
1 robinet femelle 1/4 NPT

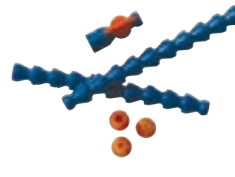

Raccord complet avec robinet femelle 1/4 BSPT

Réf. 40461D

2 segments de 15 cm,
1 buse droite Ø 1.6 mm,
1 buse droite Ø 3.2 mm,
1 buse droite Ø 6.35 mm,
1 robinet femelle 1/4 BSPT

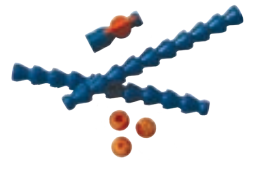

Support pour dérivation en T



Réf. 21195D
pack de 2

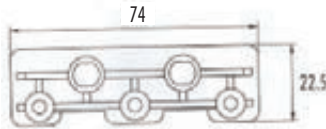

Kit dérivation en T

Réf. 21199D

1 support pour dérivation
en T,
3 dérivation en T,
1 coude à 90° mâle/femelle



Kit dérivation en T complet

Réf. 21198D

1 kit dérivation en T,
5 robinets en ligne



Kit arrosage circulaire

Réf. 41479D

15 buses intermédiaires
en T Ø 1.8 mm,
1 bouchon obturateur

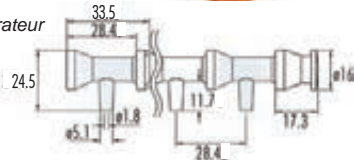

Kit avec robinet sur base magnétique

Réf. 41420D

1 base magnétique,
1 robinet en ligne,
1 segment 1/4 de 30 cm,
1 buse plate L 25 mm x Ep 1.7 mm

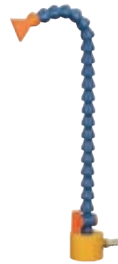

Pince d'assemblage aluminium 1/4"

Réf. 78001D



RACCORDS D'ENTRÉE 1/4"

Raccord entrée mâle
fileté 1/8" NPT



Réf. 41405D
pack de 4

Réf. 49425D
pack de 50

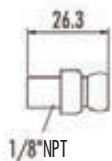

Raccord entrée mâle
fileté 1/8" BSPT



Réf. 41417D
pack de 4

Réf. 49437D
pack de 50

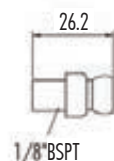

Raccord entrée mâle
fileté 1/4" NPT



Réf. 41406D
pack de 4

Réf. 49426D
pack de 50



Raccord entrée mâle
fileté 1/4" BSPT



Réf. 41418D
pack de 4

Réf. 49438D
pack de 50

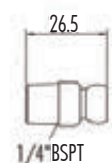

Raccord entrée
femelle fileté 7/16" UNF



Réf. 41414D
pack de 4

Réf. 49434D
pack de 20



Raccord entrée
femelle fileté 5/8" UNF



Réf. 41412D
pack de 4

Réf. 49432D
pack de 20



Robinet mâle 1/4"
NPT



Réf. 21192D
pack de 2

Réf. 29452D
pack de 10

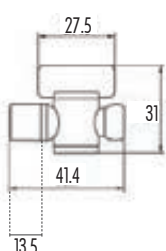

Robinet mâle 1/4"
BSPT



Réf. 21201D
pack de 2

Réf. 21211D
pack de 10

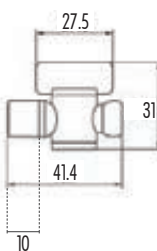

Robinet femelle 1/4"
NPT



Réf. 21193D
pack de 2

Réf. 29453D
pack de 10

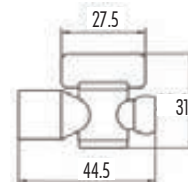

Robinet femelle 1/4"
BSPT



Réf. 21202D
pack de 2

Réf. 21212D
pack de 10

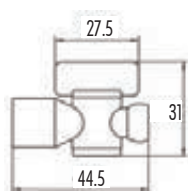

Machines à laver

Version ECO

Version MINI inox

Dégraissage sous haute pression

Pompe électrique haute pression
50 bars

Capacité utile : 95 x 70 x H 55 cm
70 kgs

ÉLÉMENTS INTERMÉDIAIRES 1/4"

Manchon double
femelle/femelle

Réf. 41409D
pack de 4

Réf. 49429D
pack de 20



Valve anti-retour

Réf. 21191D
pack de 2

Réf. 29451D
pack de 10

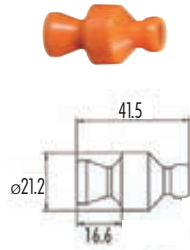

Buse intermédiaire en T
Ø1.8

Réf. 41478D
pack de 4

Réf. 49443D
pack de 20

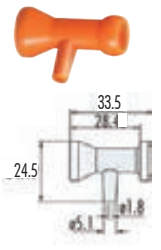

Coude à 90°
mâle/femelle

Réf. 41415D
pack de 2

Réf. 49435D
pack de 20

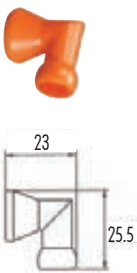

Dérivation en T

Réf. 41416D
pack de 2

Réf. 49436D
pack de 20

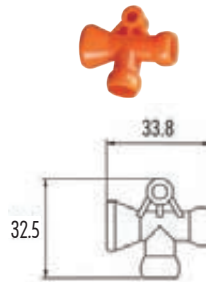

Dérivation en Y

Réf. 41408D
pack de 2

Réf. 49428D
pack de 20



Robinet en ligne

Réf. 21194D
pack de 2

Réf. 29454D
pack de 10

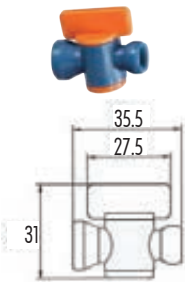

Prolongateur 95 mm

Réf. 41476D
pack de 4

Réf. 49445D
pack de 20

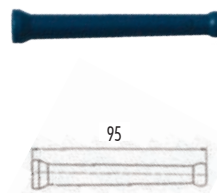

Bride avec vis

Réf. 41477D
pack de 4

Réf. 49446D
pack de 20



Kit 4 prolongateurs et
4 brides avec 4 vis

Réf. 41475D

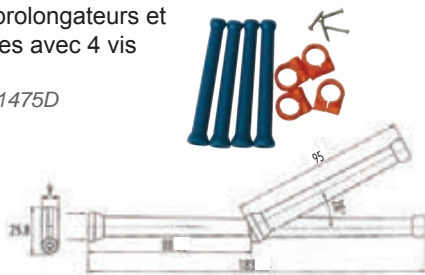

Segment 1/4"

Réf. 41401D
2 segments de 15 cm
2 x 10 pièces

Réf. 41400D
segment 1 m

Réf. 49420D
segment 7.62 m

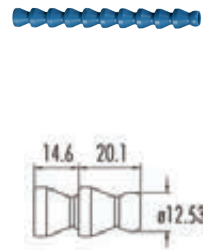

Segment 1/4"

Réf. 49421D
bobine de 15.24 m

Réf. 41410D
bobine de 25 m



ÉLÉMENTS DE SORTIE 1/4"

Buse droite
Ø1.6 mm

Réf. 41402D
pack de 4

Réf. 49422D
pack de 50

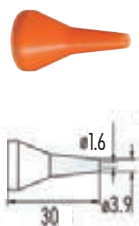

Buse droite
Ø3.2 mm

Réf. 41403D
pack de 4

Réf. 49423D
pack de 50

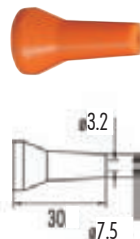

Buse droite
Ø6.35 mm

Réf. 41404D
pack de 4

Réf. 49424D
pack de 50



Buse coudée à 90°
Ø1.6 mm

Réf. 41470D
pack de 4

Réf. 49439D
pack de 20

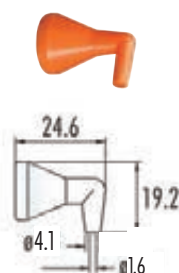

Buse coudée à 90°
Ø3.2 mm

Réf. 41471D
pack de 4

Réf. 49440D
pack de 20

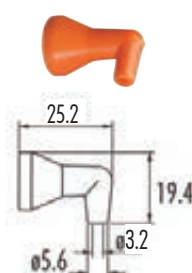

Buse coudée à 90°
Ø6.35 mm

Réf. 41472D
pack de 4

Réf. 49441D
pack de 20

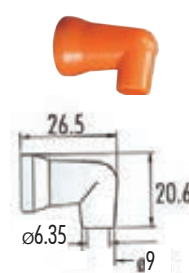

Buse coudée à 90°
multitrous Ø2.4 mm

Réf. 41473D
pack de 2

Réf. 49442D
pack de 20

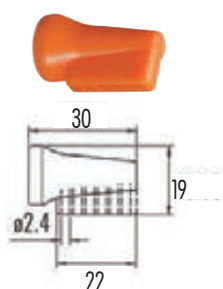

Kit 4 buses coudées
à 90°

Réf. 41474D
1 buse droite Ø 1.6 mm,
1 buse droite Ø 3.2 mm,
1 buse droite Ø 6.35 mm,
1 buse coudée à 90°
multitrous Ø 2.4 mm



Buse plate
L 7 mm x ep. 1.3 mm

Réf. 41500D
pack de 2

Réf. 49500D
pack de 20

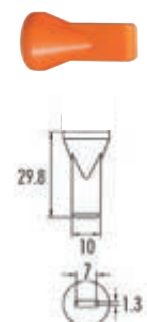

Buse plate
L 11 mm x ep. 1 mm

Réf. 41483D
pack de 4

Réf. 49451D
pack de 20



Buse plate
L 11 mm x ep. 1.5 mm

Réf. 41484D
pack de 4

Réf. 49452D
pack de 20

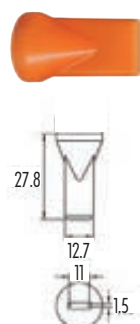

Buse plate
L 25 mm x ep. 1.7 mm

Réf. 41407D
pack de 2

Réf. 49427D
pack de 20



Buse plate L 25 mm
à jet concentré

Réf. 41489D
pack de 2

Réf. 49456D
pack de 20



Buse droite 7 trous
Ø1 L 11 mm

Réf. 41486D
pack de 4

Réf. 49454D
pack de 20

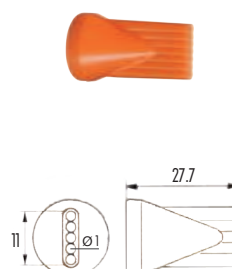

Buse droite 5 trous
Ø1.5 L 11 mm

Réf. 41485D
pack de 4

Réf. 49453D
pack de 20

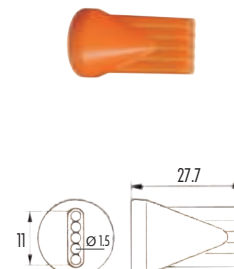

ÉLÉMENTS DE SORTIE 1/4" (suite)

Buse droite multitrans
Ø1 L 40 mm

Réf. 41481D
pack de 2

Réf. 49449D
pack de 20

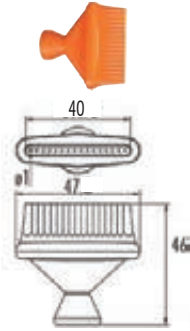

Buse droite multitrans
Ø1.5 L 40 mm

Réf. 41482D
pack de 2

Réf. 49450D
pack de 20

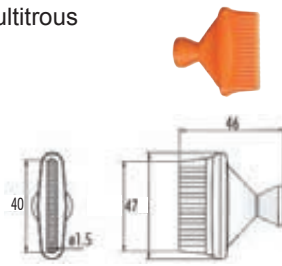

Buse droite multitrans
Ø1.9 L 63.5 mm

Réf. 41488D
pack de 2

Réf. 49455D
pack de 20

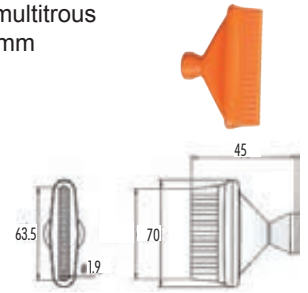

Raccord sortie femelle
filé 1/8" NPT

Réf. 41411D
pack de 4

Réf. 49431D
pack de 20

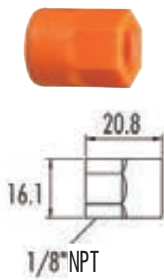

Raccord sortie femelle
filé 1/4" NPT

Réf. 21205D
pack de 4

Réf. 21215D
pack de 50

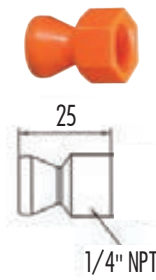

Raccord sortie femelle
filé 1/4" BSPT

Réf. 21204D
pack de 4

Réf. 21214D
pack de 50

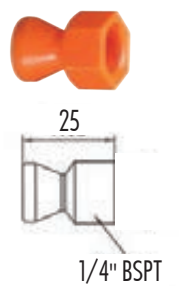

Raccord sortie mâle
filé 1/4" BSPT

Réf. 21203D
pack de 4

Réf. 21213D
pack de 50

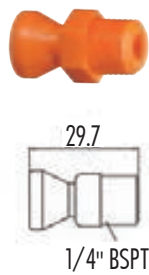

Robinet mâle 1/4" NPT
sortie pour tuyau souple

Réf. 21200D
pack de 2

Réf. 21210D
pack de 10



Bouchon obturateur

Réf. 41480D
pack de 4

Réf. 49447D
pack de 20

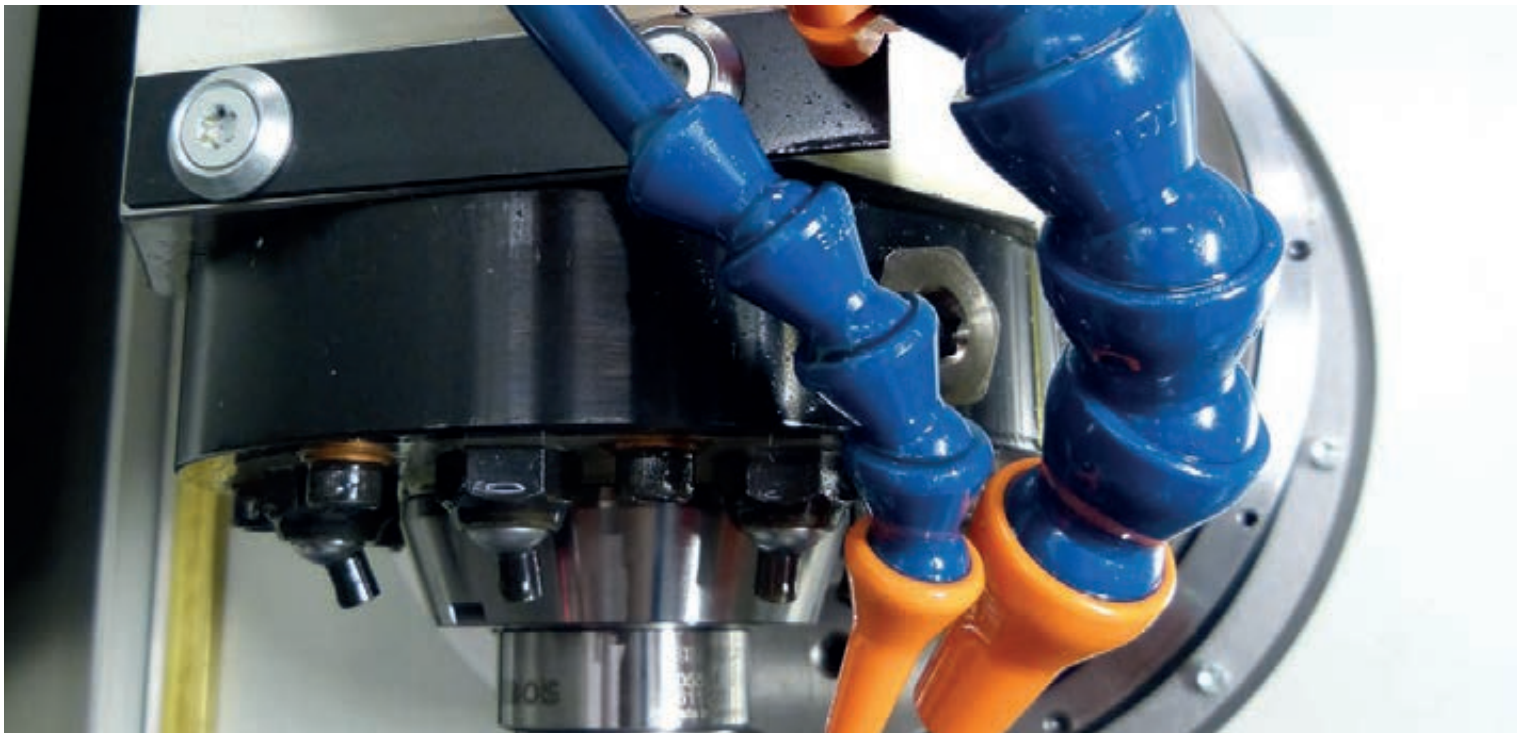

SYSTÈMES ARROSAGE 3/8"

Raccords d'entrée

page 10

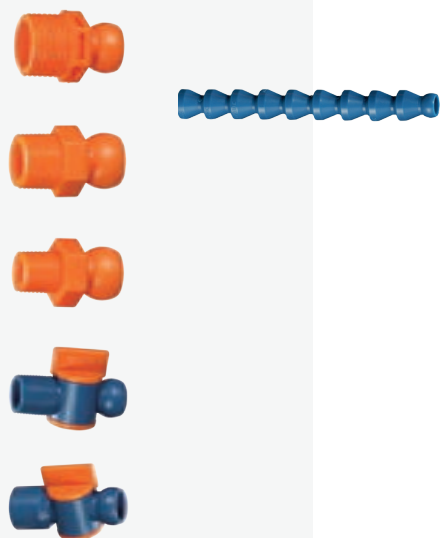

Éléments intermédiaires

page 11

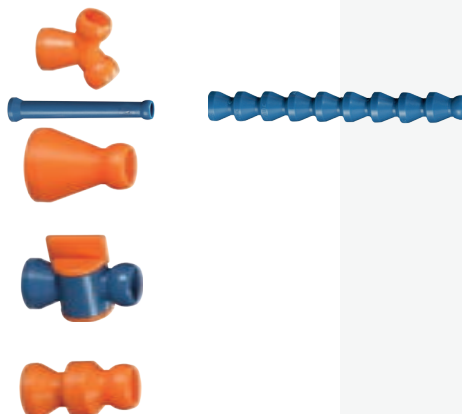

Éléments de sortie

page 11



■ Kits & Accessoires 3/8" : Page 9

KITS & ACCESSOIRES 3/8"

Kit NPT

Réf. 38040D
2 segments de 14.5 cm,
1 buse droite Ø 9.5 mm,
1 raccord entrée mâle fileté
3/8" NPT



Kit BSPT

Réf. 38030D
2 segments de 14.5 cm,
1 buse droite Ø 9.5 mm,
1 raccord entrée mâle fileté
3/8" BSPT

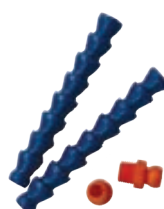

Kit NPT Complet

Réf. 38431D
2 segments de 13.5 cm,
1 buse droite Ø 6.35 mm,
1 buse droite Ø 9.5 mm,
1 buse droite Ø 12.7 mm,
1 raccord entrée mâle fileté
3/8" NPT,
1 raccord entrée mâle fileté
1/2" NPT



Kit BSPT Complet

Réf. 38430D
2 segments de 14.5 cm,
1 buse droite Ø 6.35 mm,
1 buse droite Ø 9.5 mm,
1 buse droite Ø 12.7 mm,
1 raccord entrée mâle fileté
3/8" BSPT,
1 raccord entrée mâle fileté
1/2" BSPT



Raccord complet avec robinet mâle 3/8" NPT

Réf. 38201D
2 segments de 14.5 cm,
1 buse droite Ø 6.35 mm,
1 buse droite Ø 9.5 mm,
1 buse droite Ø 12.7 mm,
1 robinet mâle 3/8" NPT



Raccord complet avec robinet mâle 3/8" BSPT

Réf. 38200D
2 segments de 14.5 cm,
1 buse droite Ø 6.35 mm,
1 buse droite Ø 9.5 mm,
1 buse droite Ø 12.7 mm,
1 robinet mâle 3/8" BSPT



Raccord complet avec robinet femelle 3/8" NPT

Réf. 38203D
2 segments de 14.5 cm,
1 buse droite Ø 6.35 mm,
1 buse droite Ø 9.5 mm,
1 buse droite Ø 12.7 mm,
1 robinet femelle 3/8" NPT

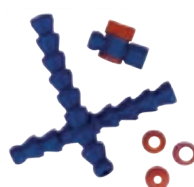

Raccord complet avec robinet femelle 3/8" BSPT

Réf. 38202D
2 segments de 14.5 cm,
1 buse droite Ø 6.35 mm,
1 buse droite Ø 9.5 mm,
1 buse droite Ø 12.7 mm,
1 robinet femelle 3/8" BSPT

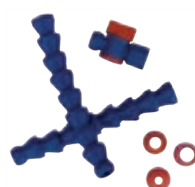

Pince d'assemblage aluminium 3/8"

Réf. 38173D



RACCORDS D'ENTRÉE 3/8"

Raccord entrée mâle
fileté 1/4" BSPT

Réf. 38026D
pack de 4

Réf. 38046D
pack de 50

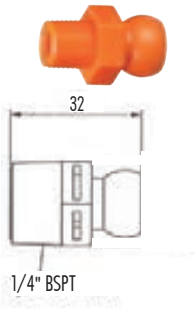

Raccord entrée mâle
fileté 3/8" NPT

Réf. 38135D
pack de 4

Réf. 38155D
pack de 50

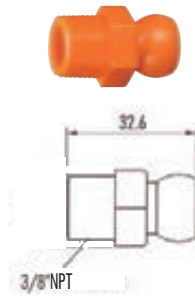

Raccord entrée mâle
fileté 3/8" BSPT

Réf. 38035D
pack de 4

Réf. 38055D
pack de 50

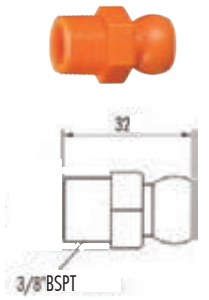

Raccord entrée mâle
fileté 1/2" NPT

Réf. 38136D
pack de 4

Réf. 38156D
pack de 50

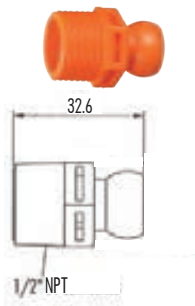

Raccord entrée mâle
fileté 1/2" BSPT

Réf. 38036D
pack de 4

Réf. 38056D
pack de 50

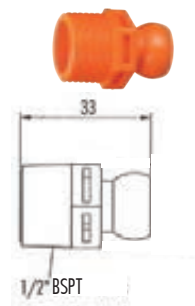

Robinet mâle 3/8"
NPT

Réf. 38723D
pack de 2

Réf. 38743D
pack de 10

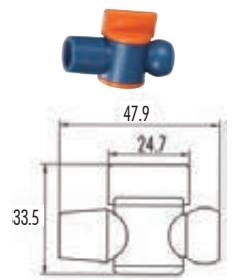

Robinet mâle 3/8"
BSPT

Réf. 38726D
pack de 2

Réf. 38746D
pack de 10

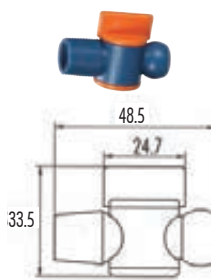

Robinet femelle 3/8"
NPT

Réf. 38724D
pack de 2

Réf. 38744D
pack de 10



Robinet femelle 3/8"
BSPT

Réf. 38727D
pack de 2

Réf. 38747D
pack de 10

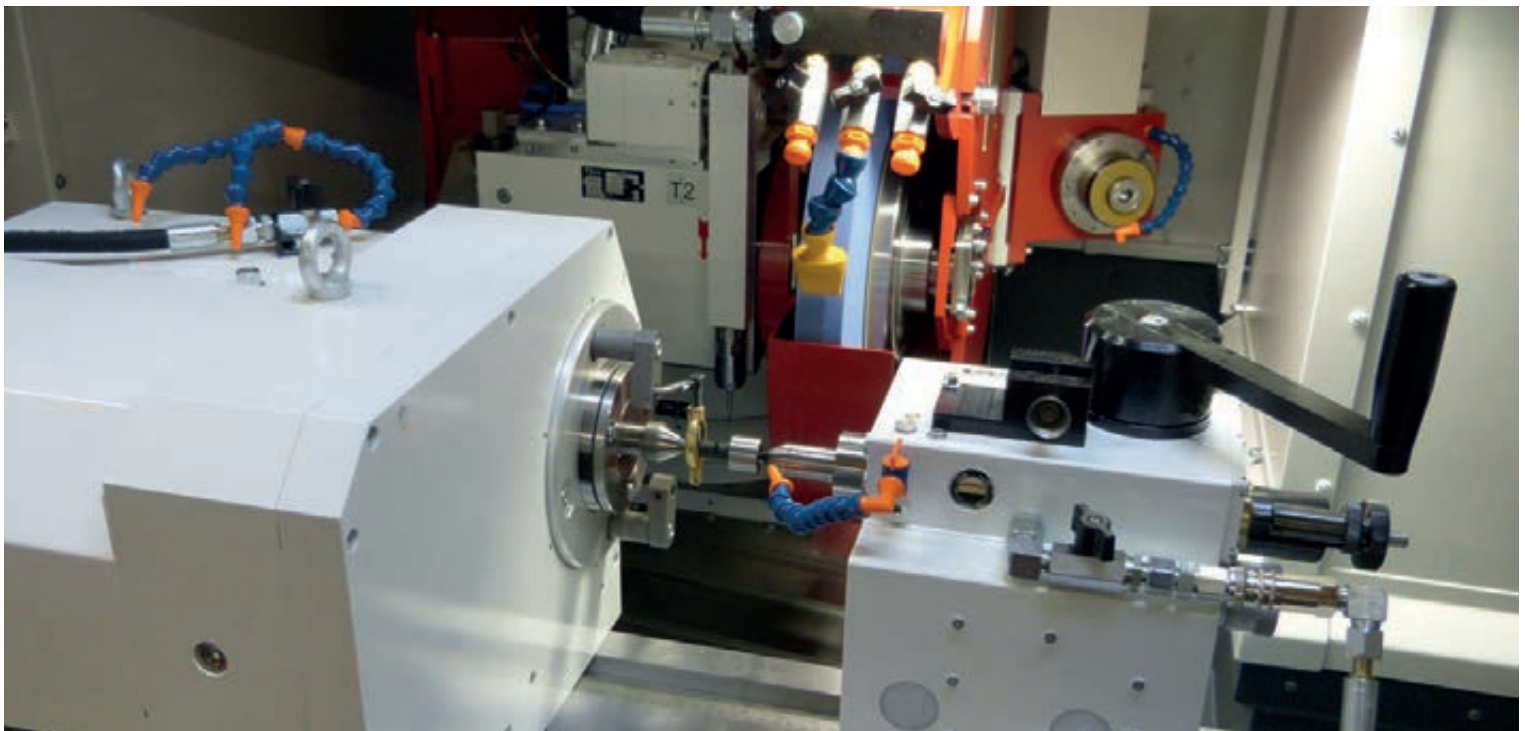
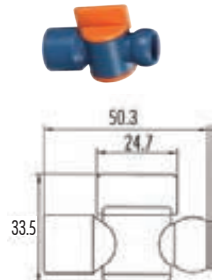

ÉLÉMENTS INTERMÉDIAIRES 3/8"

Valve anti-retour

Réf. 38725D
pack de 2

Réf. 38745D
pack de 10

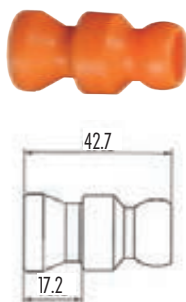

Dérivation en Y

Réf. 38038D
pack de 2

Réf. 38058D
pack de 20

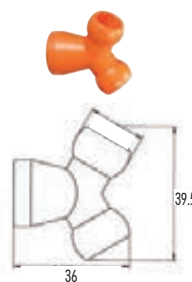

Réducteur droit 3/8" vers 1/4"

Réf. 38651D
pack de 2

Réf. 38851D
pack de 20

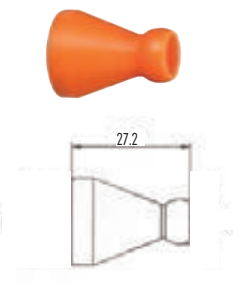

Robinet en ligne

Réf. 38722D
pack de 2

Réf. 38742D
pack de 10

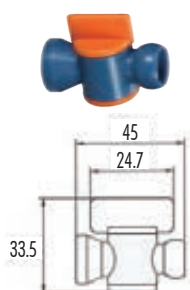

Segment 3/8"

Réf. 38031D
2 segments 14.5 cm
2 x 8 pièces

Réf. 38041D
segment 1 m

Réf. 38051D
segment 7.62 m

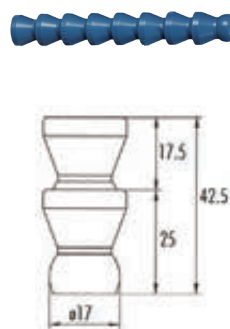

Segment 3/8"

Réf. 38091D
bobine de 15.24 m



ÉLÉMENTS DE SORTIE 3/8"

Buse droite Ø6.35 mm

Réf. 38032D
pack de 4

Réf. 38052D
pack de 50

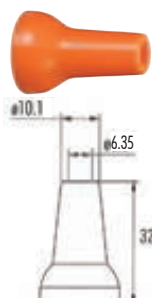

Buse droite Ø9.5 mm

Réf. 38033D
pack de 4

Réf. 38053D
pack de 50

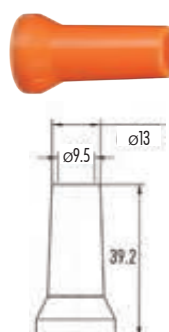

Buse droite Ø12.7 mm

Réf. 38034D
pack de 4

Réf. 38054D
pack de 50

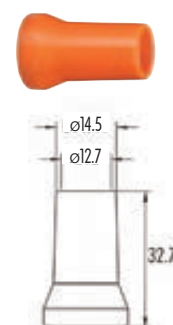

Buse plate L 32 mm x Ep. 3.2 mm

Réf. 38037D
pack de 2

Réf. 38057D
pack de 20



Raccords d'entrée

page 14



Éléments intermédiaires

page 15

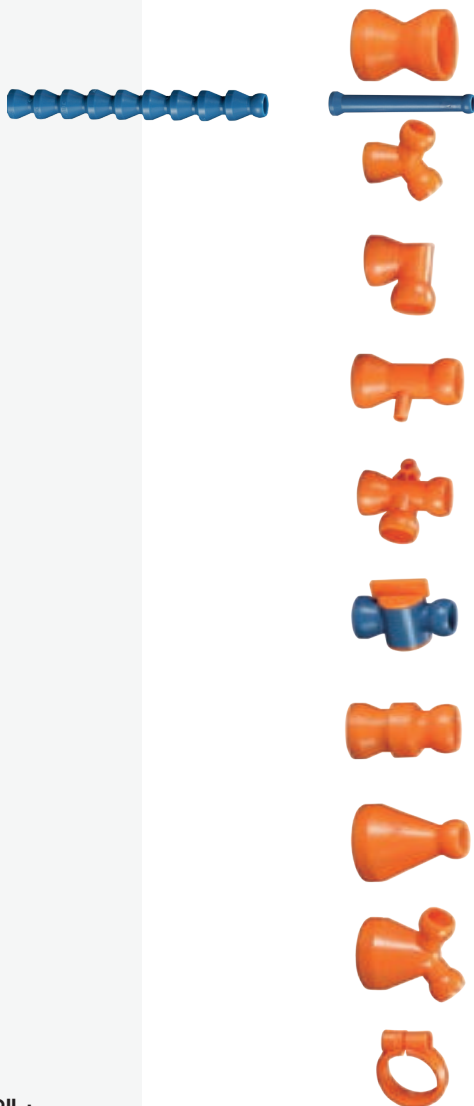

Éléments de sortie

page 16-17



■ Kits & Accessoires 1/2" : Page 13



KITS & ACCESSOIRES 1/2"

Kit NPT

Réf. 50813D
 2 segments de 13.5 cm,
 1 buse droite Ø 6.35 mm,
 1 buse droite Ø 9.5 mm,
 1 buse droite Ø 12.7 mm,
 1 raccord entrée mâle fileté
 3/8" NPT,
 1 raccord entrée mâle fileté
 1/2" NPT

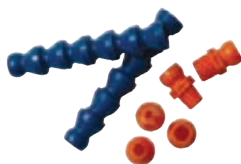

Kit BSPT

Réf. 50814D
 2 segments de 13.5 cm,
 1 buse droite Ø 6.35 mm,
 1 buse droite Ø 9.5 mm,
 1 buse droite Ø 12.7 mm,
 1 raccord entrée mâle fileté
 3/8 BSPT,
 1 raccord entrée mâle fileté
 1/2" BSPT

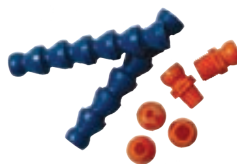

Raccord complet avec robinet mâle 1/2" NPT

Réf. 50816D
 2 segments de 13.5 cm,
 1 buse droite Ø 6.35 mm,
 1 buse droite Ø 9.5 mm,
 1 buse droite Ø 12.7 mm,
 1 robinet mâle 1/2" NPT

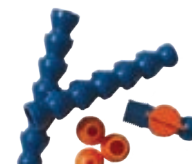

Raccord complet avec robinet mâle 1/2" BSPT

Réf. 50815D
 2 segments de 13.5 cm,
 1 buse droite Ø 6.35 mm,
 1 buse droite Ø 9.5 mm,
 1 buse droite Ø 12.7 mm,
 1 robinet mâle 1/2" BSPT

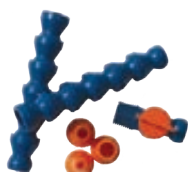

Raccord complet avec robinet femelle 1/2" NPT

Réf. 50818D
 2 segments de 13.5 cm,
 1 buse droite Ø 6.35 mm,
 1 buse droite Ø 9.5 mm,
 1 buse droite Ø 12.7 mm,
 1 robinet femelle 1/2" NPT

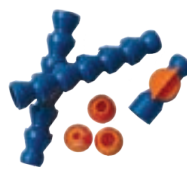

Raccord complet avec robinet femelle 1/2" BSPT

Réf. 50817D
 2 segments de 13.5 cm,
 1 buse droite Ø 6.35 mm,
 1 buse droite Ø 9.5 mm,
 1 buse droite Ø 12.7 mm,
 1 robinet femelle 1/2" BSPT

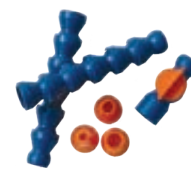

Support pour dérivation en T

Réf. 32095D
 pack de 2

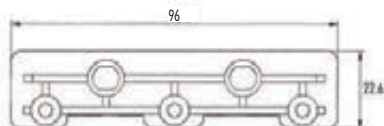

Kit dérivation en T

Réf. 32099D
 1 support pour dérivation
 en T,
 3 dérivation en T,
 1 coude à 90° mâle/femelle



Kit dérivation en T complet

Réf. 32098D
 1 kit dérivation en T,
 5 robinets en ligne

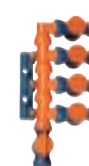

Kit arrosage circulaire

Réf. 51837D
 15 buses intermédiaires en T
 Ø 3.35 mm,
 1 bouchon obturateur

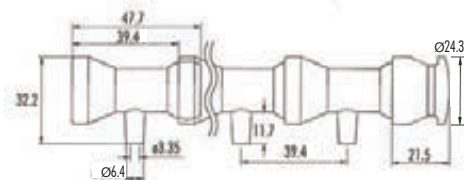

Pince d'assemblage aluminium 1/2"

Réf. 78002D



RACCORDS D'ENTRÉE 1/2"

Raccord entrée femelle fileté 5/8" UNF

Réf. 51823D
pack de 4

Réf. 59873D
pack de 20



Raccord entrée mâle fileté 3/8" NPT

Réf. 51804D
pack de 4

Réf. 59864D
pack de 50



Raccord entrée mâle fileté 3/8" BSPT

Réf. 51826D
pack de 4

Réf. 59876D
pack de 50

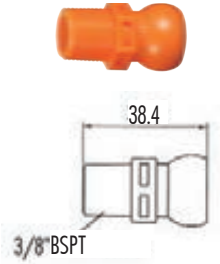

Raccord entrée mâle fileté 1/2" NPT

Réf. 51805D
pack de 4

Réf. 59865D
pack de 50

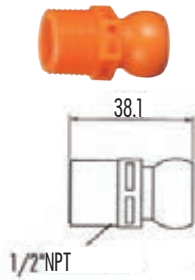

Raccord entrée mâle fileté 1/2" BSPT

Réf. 51827D
pack de 4

Réf. 59877D
pack de 50



Robinet mâle 1/2" NPT

Réf. 32092D
pack de 2

Réf. 39852D
pack de 10

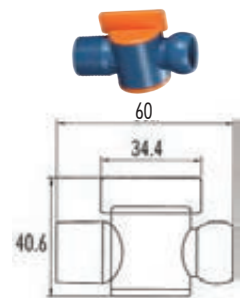

Robinet mâle 1/2" BSPT

Réf. 21221D
pack de 2

Réf. 21231D
pack de 10

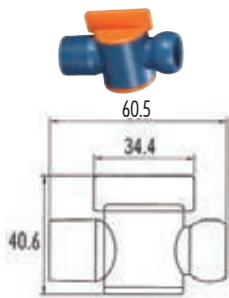

Robinet femelle 1/2" NPT

Réf. 32093D
pack de 2

Réf. 39853D
pack de 10

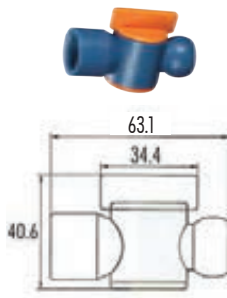

Robinet femelle 1/2" BSPT

Réf. 21222D
pack de 2

Réf. 21232D
pack de 10

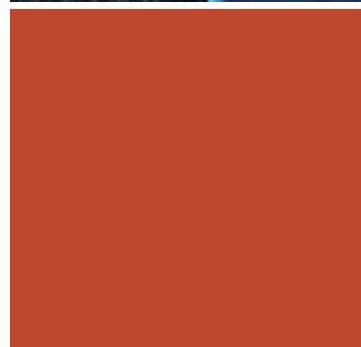
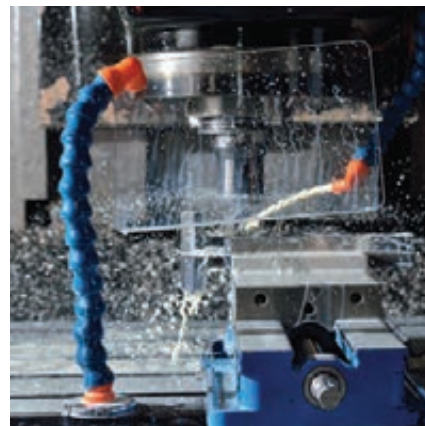
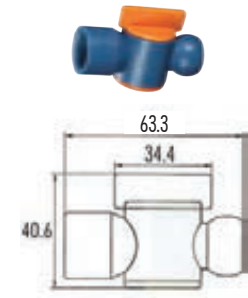

ÉLÉMENTS INTERMÉDIAIRES 1/2"

Manchon double femelle/femelle

Réf. 51811D
pack de 4

Réf. 59872D
pack de 20



Valve anti-retour

Réf. 32091D
pack de 2

Réf. 39851D
pack de 10



Buse intermédiaire en T Ø3.35 mm

Réf. 51836D
pack de 4

Réf. 59889D
pack de 20

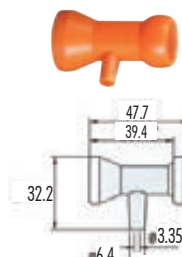

Coude à 90° mâle/femelle

Réf. 51824D
pack de 2

Réf. 59874D
pack de 20

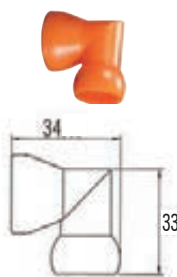

Dérivation en T

Réf. 51825D
pack de 2

Réf. 59875D
pack de 20

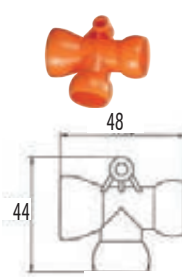

Dérivation en Y

Réf. 51808D
pack de 2

Réf. 59868
pack de 20



Réducteur droit 1/2" vers 1/4"

Réf. 51821D
pack de 2

Réf. 59869D
pack de 20

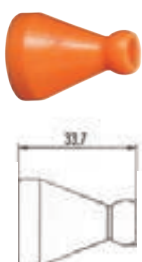

Réducteur en Y 1/2" vers 1/4"

Réf. 51822D
pack de 2

Réf. 59870D
pack de 20

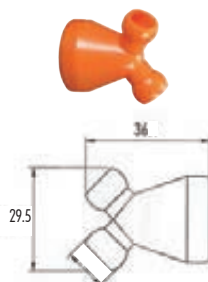

Robinet en ligne

Réf. 32094D
pack de 2

Réf. 39854D
pack de 10

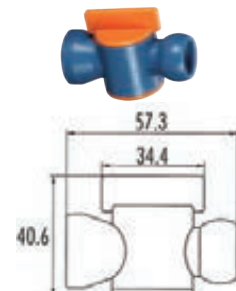

Prolongateur 97 mm

Réf. 51833D
pack de 4

Réf. 59883D
pack de 20

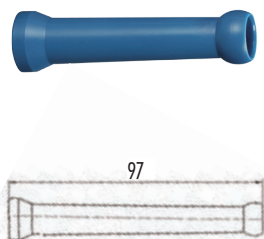

Bride avec vis

Réf. 51834D
pack de 4

Réf. 59884D
pack de 20



Kit 4 prolongateurs et 4 brides avec 4 vis

Réf. 51835D

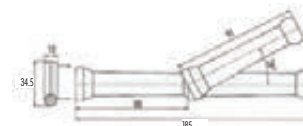

Segment 1/2"

Réf. 51801D
2 segments 13.5 cm
2 x 6 pièces

Réf. 51800D
segment 1 m

Réf. 59860D
segment 7.62 m

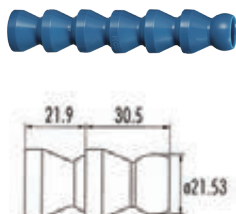

Segment 1/2"

Réf. 59861D
bobine de 15.24 m

Réf. 51810D
bobine de 25 m



ÉLÉMENTS DE SORTIE 1/2"

Buse droite Ø6.35 mm

Réf. 51806D
pack de 4

Réf. 59866D
pack de 50

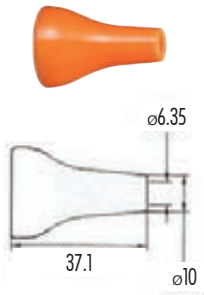

Buse droite Ø9.5 mm

Réf. 51802D
pack de 4

Réf. 59862D
pack de 50

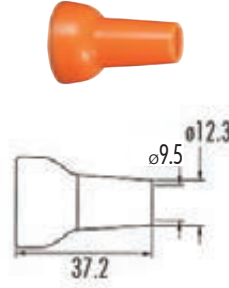

Buse droite Ø12.7 mm

Réf. 51803D
pack de 4

Réf. 59863D
pack de 50

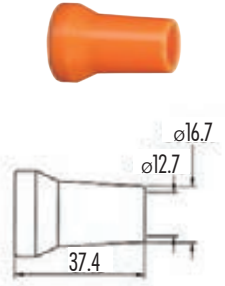

Buse coudée à 90°
Ø6.35 mm

Réf. 51828D
pack de 4

Réf. 59878D
pack de 20

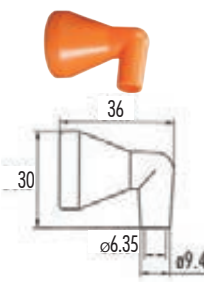

Buse coudée à 90°
Ø9.5 mm

Réf. 51829D
pack de 4

Réf. 59879D
pack de 20

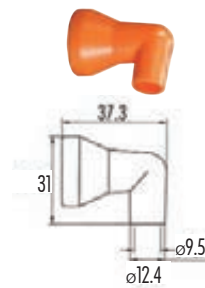

Buse coudée à 90°
Ø12.7 mm

Réf. 51830D
pack de 4

Réf. 59880D
pack de 20

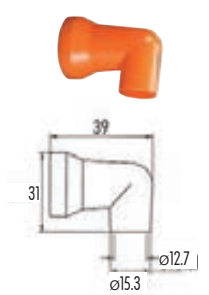

Buse coudée à 90°
multitrous Ø4.2 mm

Réf. 51831D
pack de 2

Réf. 59881D
pack de 20

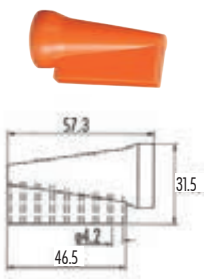

Kit de 4 buses coudées
à 90°

Réf. 51832D

1 buse coudée Ø 6.35 mm,
1 buse coudée Ø 9.5 mm,
1 buse coudée Ø 12.7 mm,
1 buse coudée 90° multitrous
Ø 4.2 mm



Buse plate L 18 mm x
Ep. 2 mm

Réf. 51840D
pack de 4

Réf. 59890D
pack de 20



Buse plate L 18 mm x
Ep. 3.2 mm

Réf. 51841D
pack de 4

Réf. 59891D
pack de 20

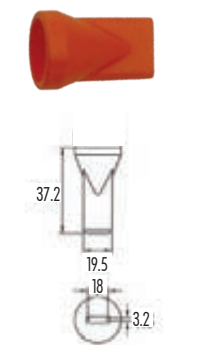

Buse plate L 30 mm
à jet concentré

Réf. 51847D
pack de 2

Réf. 59897D
pack de 20

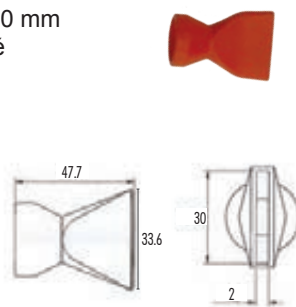

Buse plate L 31.9 mm x
Ep. 4.5 mm

Réf. 51807D
pack de 2

Réf. 59867D
pack de 20

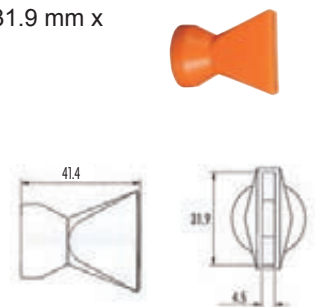

Buse plate L 40 mm
à jet concentré

Réf. 51848D
pack de 2

Réf. 59898D
pack de 20

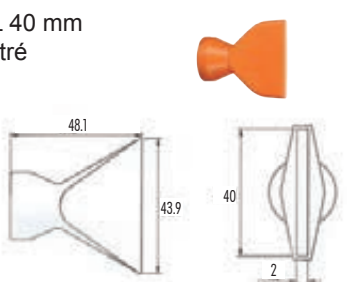

Buse plate L 47.3 mm x
Ep. 4.6 mm

Réf. 51812D
pack de 2

Réf. 59852D
pack de 20

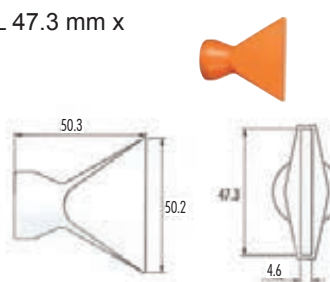

Buse plate L 61 mm x
Ep. 3.4 mm

Réf. 51809D
pack de 2

Réf. 59871D
pack de 20

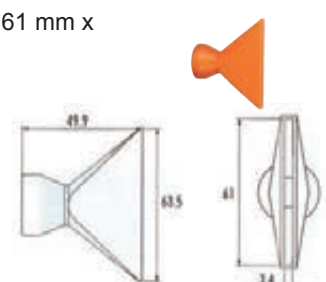

ÉLÉMENTS DE SORTIE 1/2" (suite)

Buse droite 7 trous
Ø2 L 18 mm



Réf. 51843D
pack de 4

Réf. 59893D
pack de 20

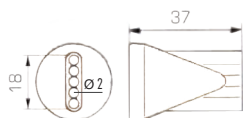

Buse droite 5 trous
Ø3.2 L 18 mm



Réf. 51842D
pack de 4

Réf. 59892D
pack de 20

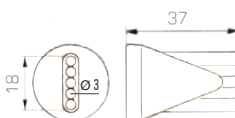

Buse droite multitrous
Ø1.9 L 63.5 mm



Réf. 51845D
pack de 2

Réf. 59895D
pack de 20

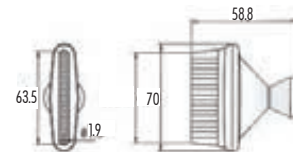

Bouchon obturateur



Réf. 51838D
pack de 4

Réf. 59885D
pack de 20

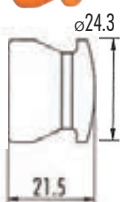

SGD
SOLUTIONS de DEGRAISSAGE

Arrosage Haute Pression - Filtration

Équipement pour le nettoyage
industriel et l'environnement

Tél. 04 50 96 17 52
info@sgd-france.com
www.sgd-france.com



SYSTÈMES ARROSAGE 3/4"

Raccords d'entrée

page 18



Éléments intermédiaires

page 19



Éléments de sortie

page 18



■ Kits & Accessoires 3/4" : Page 18

KITS & ACCESSOIRES 3/4"

Kit NPT

Réf. 60513D
2 segments de 15 cm,
1 buse droite Ø 16 mm,
1 buse droite Ø 19 mm,
1 raccord entrée mâle fileté
3/4" NPT



Kit BSPT

Réf. 60514D
2 segments de 15 cm,
1 buse droite Ø 16 mm,
1 buse droite Ø 19 mm,
1 raccord entrée mâle fileté
3/4" BSPT



Pince d'assemblage aluminium 3/4"

Réf. 78004D



Rotule de fixation

Réf. 60533D
pack de 2



Coude pour fixation écran protection polycarbonate

Réf. 60531D



Base magnétique avec rotule de fixation

Réf. 60532D



RACCORDS D'ENTRÉE 3/4"

Raccord entrée mâle fileté 3/4" NPT

Réf. 61505D
pack de 4

Réf. 69545D
pack de 50



Raccord entrée mâle fileté 3/4" BSPT

Réf. 61509D
pack de 4

Réf. 69549D
pack de 50



ÉLÉMENTS DE SORTIE 3/4"

Buse droite Ø16 mm

Réf. 61503D
pack de 4

Réf. 69543D
pack de 50



Buse droite Ø19 mm

Réf. 61502D
pack de 4

Réf. 69542D
pack de 50



Buse plate L 77.5 mm x Ep. 5 mm

Réf. 61507D
pack de 2

Réf. 69547D
pack de 20

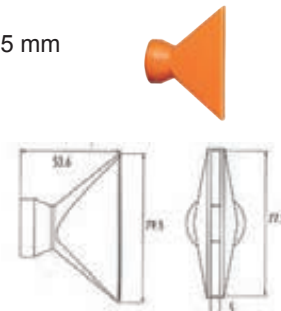

ÉLÉMENTS INTERMÉDIAIRES 3/4"

Manchon double femelle/femelle



Réf. 61514D
pack de 4

Réf. 69554D
pack de 20

Coude à 90° mâle/femelle

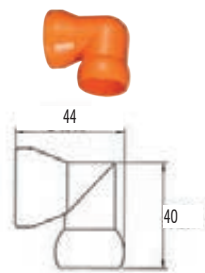

Réf. 61515D
pack de 2

Réf. 69555D
pack de 20

Dérivation en Y



Réf. 61511D
pack de 2

Réf. 69551D
pack de 20

Réducteur droit 3/4" vers 1/2"

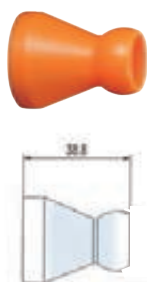

Réf. 61508D
pack de 2

Réf. 69548D
pack de 20

Réducteur en Y 3/4" vers 1/2"

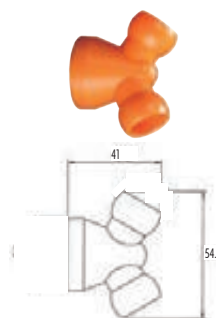

Réf. 61512D
pack de 2

Réf. 69552D
pack de 20

Segment 3/4"

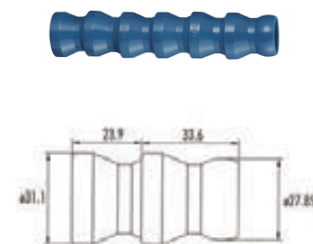

Réf. 61501D
2 segments 15 cm
2 x 6 pièces

Réf. 61500D
segment 1 m

Réf. 69540D
segment 7.62 m

Segment 3/4"



Réf. 69541D
bobine de 15.24 m

Réf. 61510D
bobine de 25 m

ACCESSOIRES DIVERS toutes tailles

Écran protection polycarbonate 152 x 203



Réf. 60528D

Écran protection polycarbonate 190 x 254



Réf. 60529D

Écran protection polycarbonate 216 x 305



Réf. 60530D

Kit écran protection polycarbonate 152 x 203 avec base magnétique



Réf. 60525D

Kit écran protection polycarbonate 190 x 254 avec base magnétique



Réf. 60526D

Kit écran protection polycarbonate 216 x 305 avec base magnétique



Réf. 60527D

SGD

SOLUTIONS de DEGRAISSAGE

Les autres gammes de produits et catalogues SGD

DÉGRAISSAGE

FILTRATION

ÉQUIPEMENTS ET PROTECTION
DE L'ENVIRONNEMENT

